

### DUOTON Bisagra de mesa invisible Redonda

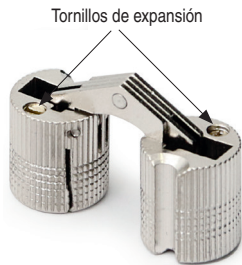

LATON  
BRASS



Tornillos de expansión

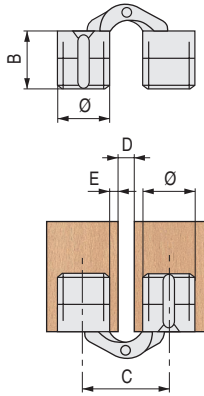

• Fijación por medio de los 2 tornillos de expansión.

CÓDIGO	Ø	B	C	D	E	Material	Acabado	
1336.4	12	13,5	20	3,5 mín.	3 máx.	latón	níquel	48
1336.5	14	15,5	23	3 mín.	3 máx.	latón	níquel	24
1336.6	16	16,5	25	3 mín.	3 máx.	latón	níquel	24
1367.1	10	11	16,5	2,5 mín.	2 máx.	latón	natural	48
1336.3	12	13,5	20	3,5 mín.	3 máx.	latón	natural	48
1336.2	14	15,5	23	3 mín.	3 máx.	latón	natural	24
1367.2	16	16,5	25	3 mín.	3 máx.	latón	natural	24
1367.6	18	17,5	27	3 mín.	3 máx.	latón	natural	24
1367.7	24	25	36,5	3 mín.	3 máx.	latón	natural	10

### PRIOVA Bisagra de mesa invisible Ovalada de 12x32mm.

Tornillos de expansión

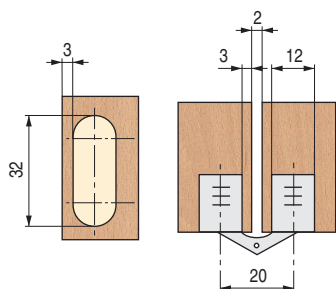
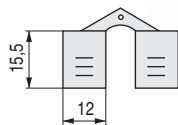
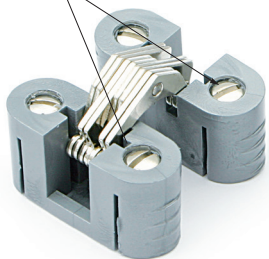

• Fijación por medio de los 4 tornillos de expansión.

CÓDIGO	Material	Acabado	
1367.3	plástico	marrón	24
1367.23	plástico	gris	24

### PRIMA Bisagra de mesa invisible Redonda

ALK®

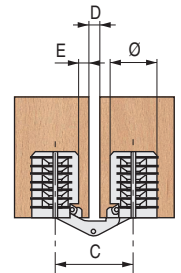
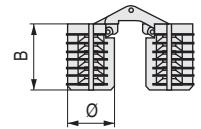

• Se inserta a presión.

CÓDIGO	Ø	B	C	D	E	Material	Acabado	
1351.2	12	18	20	3,5 mín.	2,2 máx.	plástico	beige	1.500
1351.1	14	20	23	3 mín.	3 máx.	plástico	beige	1.000
1351.4	12	18	20	3,5 mín.	2,2 máx.	plástico	gris	1.500
1351.3	14	20	23	3 mín.	3 máx.	plástico	gris	1.000

### KAPA Bisagra de mesa invisible Ovalada de 12x33,5mm.

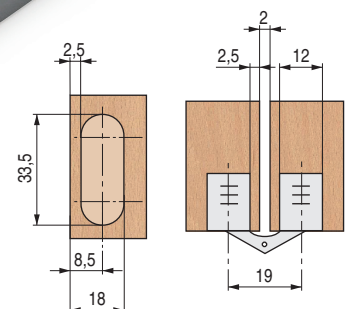
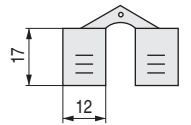
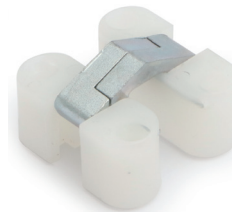

CÓDIGO	Material	Acabado	
902.161	plástico	gris	32
902.177	plástico	blanco	32